



## 2/2- and 3/2 way Bürkert TwinPower Rocker-Solenoid Valve with separating diaphragm

- For highest chemical resistance requirements
- Ultra compact design due to Bürkert Twinpower-actuator with 10.3 mm width
- DN0.8 (5 bar) and DN1.6 (2 bar)
- Integrated hit and hold electronic
- High back pressure tightness with excellent cleanability

Type 6624 combines the reliable and successful Rocker principle with a highly innovative new actuator. The Bürkert TwinPower concept of this actuator reduces the size greatly without loss in performance. Hence the 10 mm wide medium isolated rocker valve, 6624, with a 1.6 mm orifice and a pressure resistance of 2 bar, provides the same performance as a traditional 16 mm valve. In addition, the integrated power reduction decreases the energy consumption by 75%. In combination with other design features the heat transfer into the medium can be reduced to a minimum.

In the design of the 6624, the main benefits lie in its excellent cleanability and a high reliability. By using high performance materials the 6624 suits the handling of aggressive medium perfectly. The valve is available in a 2-way and 3-way version.

### Circuit function A

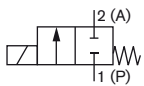

2/2 way direct-acting solenoid valve, normally closed

### Circuit function B

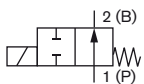

2/2 way direct-acting solenoid valve, normally open

### Circuit function T

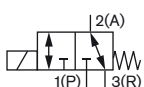

3/2 way direct-acting solenoid valve, flow direction optional

Technical Data	
<b>Orifice</b>	DN0.8 mm (Vac...5 bar), DN1.6 mm (Vac...2 bar)
<b>Body material</b>	PEEK / PPS
<b>Seal material</b>	FFKM / FKM / EPDM
<b>Medium</b>	Resistant to neutral and aggressive gases and liquids acc. to our chemical resistance chart
<b>Medium temperature</b>	
FFKM	+ 15 ... + 50 °C
FKM	- 10 ... + 50 °C
EPDM	- 10 ... + 50 °C (for orifice DN0.8) + 5 ... + 50 °C (for orifice DN1.6)
<b>Ambient temperature</b>	
FFKM	+ 15 ... + 55 °C
FKM	- 10 ... + 55 °C
EPDM	- 10 ... + 55 °C
<b>Internal volume</b>	< 100 µl
<b>Port connection</b>	Sub-base / UNF / Tube connection
<b>Electrical connection</b>	Flying leads, Rectangular plug
<b>Power supply</b>	24 V <sup>1)</sup> / 12 V <sup>1)</sup>
<b>Voltage tolerance</b>	
24 V	± 10% <sup>2)</sup>
12 V	+ 10% / - 5% <sup>2)</sup>
<b>Nominal power consumption</b>	4 W inrush power 1 W nominal holding power (internal power reduction)
<b>Duty cycle</b>	100% continuous rating
<b>Installation</b>	As required
<b>Protection class</b>	IP40
<b>Switching frequency</b>	max. 5 Hz <sup>3)</sup>
<b>Response times<sup>3)</sup></b>	Acc. DIN 12238
opening	ca. 10 ms (Pressure rise 0 ... 10%)
closing	ca. 13 ms (Pressure drop 100 ... 90%)

<sup>1)</sup> Battery voltage, observe polarity (red = +, black = -)

<sup>2)</sup> Max. allowed ripple

<sup>3)</sup> with ambient temperature of 20 °C

Dimensions [mm]

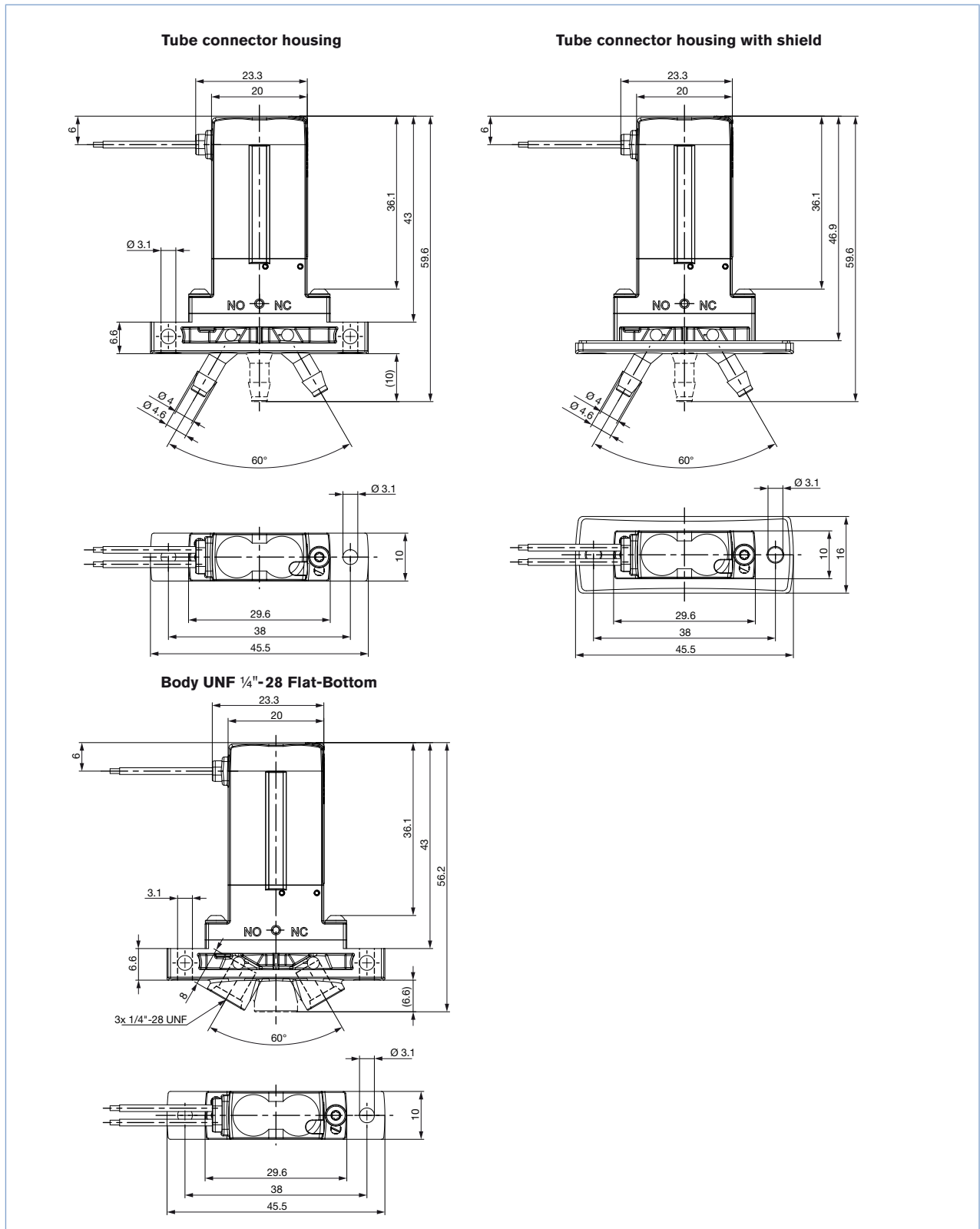



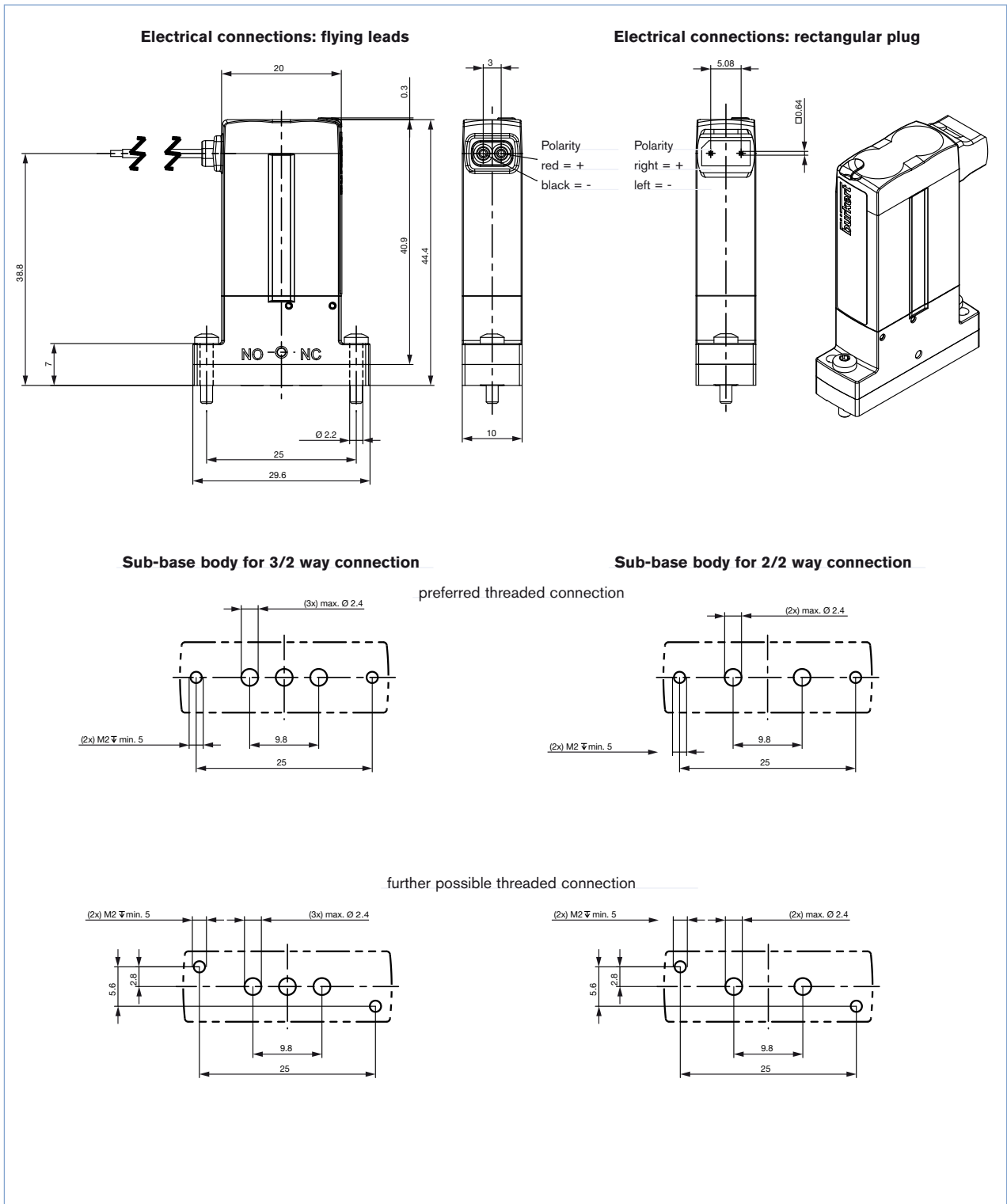





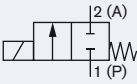

















Dimensions [mm]



DTS 1000155774 EN Version: H Status: RL (released | freigegeben | valide) printed: 19.02.2018

## Ordering chart (Sample of available versions. Others on request.)

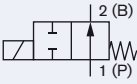
Circuit function	Orifice [mm]	Port connection	K <sub>v</sub> value water [m <sup>3</sup> /h] <sup>1)</sup>	Pressure range [bar] <sup>2)</sup>	Max. pressure difference [bar]	Seal material	Body material	Electrical connection	Voltage/Frequency [V/Hz]	Article no.
<b>A</b>  2/2 way valve, NC	0.8	Sub-base	0.01	Vac...5	5	EPDM	PPS	Flying leads	12	241341 
	0.8	Sub-base	0.01	Vac...5	5	EPDM	PPS	Rectangular plug <sup>3)</sup>	12	241398 
	0.8	Sub-base	0.01	Vac...5	5	EPDM	PPS	Flying leads	24	241342 
	0.8	Sub-base	0.01	Vac...5	5	EPDM	PPS	Rectangular plug <sup>3)</sup>	24	241399 
	0.8	Sub-base	0.01	Vac...5	5	FFKM	PEEK	Flying leads	12	241344 
	0.8	Sub-base	0.01	Vac...5	5	FFKM	PEEK	Flying leads	24	227015 
	0.8	Sub-base	0.01	Vac...5	5	FKM	PPS	Rectangular plug <sup>3)</sup>	12	241405 
	0.8	Sub-base	0.01	Vac...5	5	FKM	PPS	Flying leads	24	241351 
	0.8	UNF	0.01	Vac...5	5	FFKM	PEEK	Flying leads	24	241346 
	0.8	UNF	0.01	Vac...5	5	FKM	PEEK	Flying leads	24	241349 
	0.8	UNF	0.01	Vac...5	5	FKM	PEEK	Rectangular plug <sup>3)</sup>	24	241404 
	1.6	Sub-base	0.04	Vac...2	2	EPDM	PPS	Rectangular plug <sup>3)</sup>	12	241412 
	1.6	Sub-base	0.04	Vac...2	2	EPDM	PPS	Rectangular plug <sup>3)</sup>	24	241413 
	1.6	Sub-base	0.04	Vac...2	2	FFKM	PEEK	Flying leads	12	241359 
	1.6	Sub-base	0.04	Vac...2	2	FFKM	PEEK	Rectangular plug <sup>3)</sup>	24	229429 
	1.6	Sub-base	0.04	Vac...2	2	FKM	PPS	Flying leads	12	241367 
	1.6	Sub-base	0.04	Vac...2	2	FKM	PPS	Rectangular plug <sup>3)</sup>	12	241424 
	1.6	Sub-base	0.04	Vac...2	2	FKM	PPS	Flying leads	24	241368 
	1.6	UNF	0.04	Vac...2	2	EPDM	PEEK	Rectangular plug <sup>3)</sup>	24	241411 
	1.6	UNF	0.04	Vac...2	2	FFKM	PEEK	Flying leads	24	241361 
1.6	UNF	0.04	Vac...2	2	FKM	PEEK	Flying leads	24	241366 	
1.6	UNF	0.04	Vac...2	2	FKM	PEEK	Rectangular plug <sup>3)</sup>	24	241423 	
1.6	Tube	0.04	Vac...2	2	EPDM	PEEK	Rectangular plug <sup>3)</sup>	24	241409 	
1.6	Tube	0.04	Vac...2	2	FFKM	PEEK	Flying leads	24	237705 	
1.6	Tube	0.04	Vac...2	2	FKM	PEEK	Flying leads	24	241363 	
1.6	Tube	0.04	Vac...2	2	FKM	PEEK	Rectangular plug <sup>3)</sup>	24	241421 	
<b>B</b>  2/2 way valve, NO	0.8	Sub-base	0.01	Vac...5	5	FFKM	PEEK	Flying leads	24	on request
	1.6	Sub-base	0.04	Vac...2	2	FFKM	PEEK	Flying leads	24	on request
	1.6	Sub-base	0.04	Vac...2	2	FFKM	PEEK	Rectangular plug <sup>3)</sup>	24	on request

## Ordering chart, continued (Sample of available versions. Others on request.)

Circuit function	Orifice [mm]	Port connection	K <sub>v</sub> value water [m <sup>3</sup> /h] <sup>1)</sup>	Pressure range [bar] <sup>2)</sup>	Max. pressure difference [bar]	Seal material	Body material	Electrical connection	Voltage/Frequency [V/Hz]	Article no.
<b>T</b>	0.8	Sub-base	0.01	Vac...5	5	EPDM	PPS	Rectangular plug <sup>3)</sup>	12	241428
	0.8	Sub-base	0.01	Vac...5	5	EPDM	PPS	Rectangular plug <sup>3)</sup>	24	241429
	0.8	Sub-base	0.01	Vac...5	5	FFKM	PEEK	Flying leads	12	241373
	0.8	Sub-base	0.01	Vac...5	5	FFKM	PEEK	Flying leads	24	222936
	0.8	Sub-base	0.01	Vac...5	5	FKM	PPS	Flying leads	24	241379
3/2 way valve, universal version	0.8	Sub-base	0.01	Vac...5	5	FKM	PPS	Rectangular plug <sup>3)</sup>	12	241435
	0.8	UNF	0.01	Vac...5	5	FFKM	PEEK	Flying leads	24	241375
	0.8	UNF	0.01	Vac...5	5	FKM	PEEK	Flying leads	24	241377
	0.8	UNF	0.01	Vac...5	5	FKM	PEEK	Rectangular plug <sup>3)</sup>	24	241434
	1.6	Sub-base	0.04	Vac...2	2	EPDM	PPS	Rectangular plug <sup>3)</sup>	12	241442
	1.6	Sub-base	0.04	Vac...2	2	EPDM	PPS	Rectangular plug <sup>3)</sup>	24	241443
	1.6	Sub-base	0.04	Vac...2	2	FFKM	PEEK	Flying leads	12	239935
	1.6	Sub-base	0.04	Vac...2	2	FFKM	PEEK	Flying leads	24	227815
	1.6	Sub-base	0.04	Vac...2	2	FFKM	PEEK	Rectangular plug <sup>3)</sup>	24	229430
	1.6	Sub-base	0.04	Vac...2	2	FKM	PPS	Flying leads	12	241394
	1.6	Sub-base	0.04	Vac...2	2	FKM	PPS	Rectangular plug <sup>3)</sup>	12	241453
	1.6	Sub-base	0.04	Vac...2	2	FKM	PPS	Flying leads	24	241395
	1.6	UNF	0.04	Vac...2	2	EPDM	PEEK	Rectangular plug <sup>3)</sup>	24	241441
	1.6	UNF	0.04	Vac...2	2	FFKM	PEEK	Flying leads	24	241389
	1.6	UNF	0.04	Vac...2	2	FKM	PEEK	Rectangular plug <sup>3)</sup>	24	241452
	1.6	UNF	0.04	Vac...2	2	FKM	PEEK	Flying leads	24	241393
	1.6	Tube	0.04	Vac...2	2	EPDM	PEEK	Rectangular plug <sup>3)</sup>	24	241439
	1.6	Tube	0.04	Vac...2	2	FFKM	PEEK	Flying leads	24	241387
	1.6	Tube <sup>4)</sup>	0.04	Vac...2	2	FFKM	PEEK	Flying leads	24	242320
	1.6	Tube	0.04	Vac...2	2	FFKM	PEEK	Rectangular plug <sup>3)</sup>	24	241445
1.6	Tube	0.04	Vac...2	2	FKM	PEEK	Flying leads	24	241391	
1.6	Tube	0.04	Vac...2	2	FKM	PEEK	Rectangular plug <sup>3)</sup>	24	241450	

<sup>1)</sup> Measured at +20 °C, 1 bar pressure at value inlet and free outlet.









<sup>2)</sup> Measured as overpressure with respect to atmospheric pressure.

<sup>3)</sup> Rectangular cable plug with 300 mm flying leads; Article no. 644068 (order separately)

<sup>4)</sup> Housing has a shield for easy separation of electronics and fluidics.

**Mounting screws:** 2 pieces of VA-screws M2 x 10 (supplied as standard)

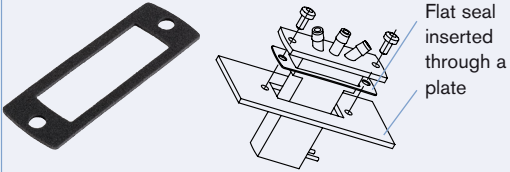
## Ordering chart accessories

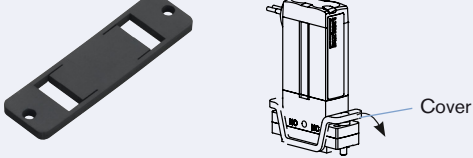
Accessories	Features	Article no.
	Rectangular plug Type 2505 with 3 m cable	133486 
	Rectangular plug Type 2505 with 300 mm flying leads	644068 
	Rectangular plug Type 2505, single contact for individual mounting	644067 
 <p data-bbox="609 855 699 958">Flat seal inserted through a plate</p>	foamed EPDM gasket for tube connector housing with shield	685294 
 <p data-bbox="609 1144 667 1167">Cover</p>	EPDM dust protection	On request

To find your nearest Bürkert office, click on the orange box →

[www.burkert.com](http://www.burkert.com)In case of special application conditions,  
please consult for advice.Subject to alterations  
© Christian Bürkert GmbH & Co. KG

1802/7\_EU-en\_00895183